



HIRSCHMANN

A **BELDEN** BRAND

User Manual

Installation

Industrial Cellular Router

OWL 4G Europe



The naming of copyrighted trademarks in this manual, even when not specially indicated, should not be taken to mean that these names may be considered as free in the sense of the trademark and tradename protection law and hence that they may be freely used by anyone.

© 2020 Hirschmann Automation and Control GmbH

Manuals and software are protected by copyright. All rights reserved. The copying, reproduction, translation, conversion into any electronic medium or machine scannable form is not permitted, either in whole or in part. An exception is the preparation of a backup copy of the software for your own use.

The performance features described here are binding only if they have been expressly agreed when the contract was made. This document was produced by Hirschmann Automation and Control GmbH according to the best of the company's knowledge. Hirschmann reserves the right to change the contents of this document without prior notice. Hirschmann can give no guarantee in respect of the correctness or accuracy of the information in this document.

Hirschmann can accept no responsibility for damages, resulting from the use of the network components or the associated operating software. In addition, we refer to the conditions of use specified in the license contract.

You can get the latest version of this manual on the Internet at the Hirschmann product site (<http://www.hirschmann.com>).

Hirschmann Automation and Control GmbH
Stuttgarter Str. 45-51
72654 Neckartenzlingen
Germany

Contents

1	Safety Instructions	8
2	CE marking	11
3	About this Manual	12
4	Router Description	13
4.1	Usage of the Router	14
5	Contents of Package	17
6	Router Design	18
6.1	Router Versions	18
6.2	Order codes	19
6.3	Basic Dimensions of the Router Box (specified in mm)	20
6.4	Mounting Recommendations	21
6.5	Removing from the DIN Rail	22
6.6	Description of the Front Panel	23
6.6.1	Status Indication	24
6.6.2	Power Connector PWR	25
6.6.3	Ethernet Port ETH0 and ETH1	26
6.6.4	ANT, DIV, GNSS and WiFi Antenna Connectors	27
6.6.5	Reset Button	28
6.7	Description of the Left Panel	30
6.7.1	SIM Card Reader	31
6.7.2	Serial Interfaces and I/O Port	32
6.8	Description of the Right Panel	34
7	First Use	35
7.1	Connecting the Router Before First Use	35
7.2	Start	35
7.3	Configuration	35
7.3.1	Configuration using a Web Browser	35
8	Maintenance and Service	37
9	Technical Parameters	38
9.1	Basic Parameters	38
9.2	Standards and Regulations	39
9.3	Type Tests and Environmental Conditions	40
9.4	Technical Parameters of Cellular Module	41
9.5	Technical Parameters of WiFi	42
9.6	Technical Parameters of GNSS	42
9.7	Other Technical Parameters	43

10 Related Documents	44
11 Further Support	45

List of Figures

1	Access to the Internet from LAN	14
2	Backed up access to the Internet	15
3	Using VPN tunnel	15
4	Serial Gateway	16
5	Version without WiFi and GNSS	18
6	Version with WiFi and GNSS	18
7	Basic dimensions of the router box	20
8	Basic dimensions of the router box	20
9	Default position of DIN rail clip	22
10	Removing from the DIN rail	22
11	The front panel of the router	23
12	Power connector	25
13	Connection of power supply	25
14	Ethernet connector	26
15	Connection of Ethernet cables	26
16	Connecting the antenna	27
17	Router reset	28
18	The left panel of the router	30
19	SIM card reader	31
20	Serial + I/O connector	32
21	Functional scheme of the binary interface	33
22	The right panel of the router	34

List of Tables

1	Contents of package	17
2	Router versions	18
3	Order Codes Overview	19
4	Description of the front panel	23
5	Status indication	24
6	Connection of power connector	25
7	Connection of Ethernet connector	26
8	Overview of router reboot and reset	29
9	Description of the left panel	30
10	Connection of RS485	32
11	Connection of I/O	32
12	Connection of RS232	32
13	Description of the right panel	34
14	Basic parameters	38
15	Standards and regulations	39
16	Type tests and environmental conditions	40
17	Technical parameters of cellular module	41
18	Technical parameters of WiFi	42
19	Technical parameters of GNSS	42
20	Other technical parameters	43

Used Symbols



Danger – Information regarding user safety.



Note – Problems that can arise in specific situations.



Information – Useful tips or information of special interest.



Example – Example of function, command or script.

1 Safety Instructions

WARNING

UNCONTROLLED MACHINE ACTIONS

To avoid uncontrolled machine actions caused by data loss, configure all the data transmission devices individually.

Before you start any machine which is controlled via data transmission, be sure to complete the configuration of all the data transmission devices.

Failure to follow these instructions can result in death, serious injury, or equipment damage.

- General safety instructions

You operate this device with electricity. Improper usage of the device entails the risk of physical injury or significant property damage. The proper and safe operation of this device depends on proper handling during transportation, proper storage and installation, and careful operation and maintenance procedures.

- ✓ Before connecting any cable, read this document, and the safety instructions and warnings.
- ✓ Operate the device with undamaged components exclusively.
- ✓ The device is free of any service components. In case of a damaged or malfunctioning device, turn off the supply voltage and return the device to Hirschmann for inspection.
- ✓ Only routers with appropriate certification and labelling should be used in locations where flammable and explosive materials are present, including gas stations, chemical plants, or locations in which explosives are used. We remind users of the duty to observe the restrictions concerning the utilization of radio devices at such places.
- ✓ Switch off the router when travelling by plane. Utilization of the router on a plane may endanger the operation of the plane or interfere with the mobile telephone network, and may be unlawful. Failure to observe these instructions may result in the suspension or cancellation of telephone services for the respective client and/or may result in legal sanctions.

- Certified usage

- ✓ Use the product only for the application cases described in the Hirschmann product information, including this manual.
- ✓ Operate the product only according to the technical specifications. See "[Technical Parameters](#)".
- ✓ Connect to the product only components suitable for the requirements of the specific application case.

- Installation site requirements

- ✓ When you are selecting the installation location, make sure you observe the climatic threshold values specified in the technical data.
- ✓ Operate the device at the specified ambient temperature (temperature of the ambient air at a distance of 2 in (5 cm)).
- ✓ Use the device in an environment with a maximum pollution degree that complies with the specifications in the technical data.
- ✓ Turn off the router and disconnect it from power supply before handling the SIM card.
- ✓ **Caution!** The SIM card could be swallowed by small children.
- ✓ Power supply must not exceed 60 V DC max.
- ✓ When using the router in close proximity to personal medical devices, such as cardiac pacemakers or hearing aids, you must proceed with heightened caution.
- ✓ The router may cause interference when used in close proximity to TV sets, radio receivers or personal computers.

- Device casing

Only technicians authorized by the manufacturer are permitted to open the casing.

- ✓ Never insert sharp objects (narrow screwdrivers, wires, etc.) into the contacts for electric conductors and do not touch the contacts.

- Qualification requirements for personnel

- ✓ Only allow qualified personnel to work on the device.

Qualified personnel have the following characteristics:

- ✓ Qualified personnel are properly trained. Training as well as practical knowledge and experience make up their qualifications. This is the prerequisite for grounding and labeling circuits, devices, and systems in accordance with current standards in safety technology.
- ✓ Qualified personnel are aware of the dangers that exist in their work.
- ✓ Qualified personnel are familiar with appropriate measures against these hazards in order to reduce the risk for themselves and others.
- ✓ Qualified personnel receive training on a regular basis.

- National and international safety regulations

- ✓ Verify that the electrical installation meets local or nationally applicable safety regulations.
- ✓ When installing antennas, observe the regulations of the country in which you are operating the WLAN device with regard to the general operating permission and the maximum emission levels.
- ✓ Install and operate this equipment with a minimum distance of 7.9 in (20 cm) between the antenna and your body.

- Recycling note

After usage, this device must be disposed of properly as electronic waste, in accordance with the current disposal regulations of your county, state, and country.

- Grounding the device

The device is grounded via the grounding screw.

- ✓ Shielding ground

The shielding ground of the connectable twisted pair cable is connected to the grounding connector as a conductor.

- ✓ Beware of possible short circuits when connecting a cable section with conductive shielding braiding.

- Data backup

- ✓ It is recommended that you create an appropriate copy or backup of all important settings that are stored in the memory of the device.

2 CE marking

The labeled devices comply with the regulations contained in the following European directive(s):

2011/65/EU and 2015/863/EU (RoHS)

Directive of the European Parliament and of the Council on the restriction of the use of certain hazardous substances in electrical and electronic equipment.

2014/53/EU (RED)

Directive of the European Parliament and of the council on the harmonization of the laws of the Member States relating to the making available on the market of radio equipment.

This product may be operated in all EU (European Union) countries.

In accordance with the above-named EU directives, the EU declaration of conformity will be at the disposal of the relevant authorities at the following address:

Hirschmann Automation and Control GmbH
Stuttgarter Str. 45-51
72654 Neckartenzlingen
Germany

The product can be used in living areas (living area, place of business, small business) and in industrial areas.

Note: The assembly guidelines provided in these instructions must be strictly adhered to in order to observe the EMC threshold values.

3 About this Manual

The "Instalation" user manual contains a device description, safety instructions, a description of the display, and the other information that you need to install the device.

Documentation mentioned in the "User Manual Installation" that is not supplied with your device as a printout can be found as PDF files for downloading on the Internet at:

<https://www.doc.hirschmann.com/>.

4 Router Description

OWL 4G Europe is an industrial cellular router intended for the market in Europe, Middle East and Africa (EMEA) area. This router is an ideal device for wireless communication in mobile networks that make use of LTE, HSPA+, UMTS, EDGE or GPRS technology. Due to the high speed of data transfer up to 150 Mbps (download) and up to 50 Mbps (upload) is this router an ideal solution for specialized M2M devices and IoT as well as for wireless connection of traffic and security camera systems, individual computers, LAN networks, automatic teller machines (ATM) and other self-service terminals.

The standard configuration includes two Ethernet 10/100 ports, serial line RS232, RS485, one binary input and one output. The device also has two readers for 3 V and 1.8 V SIM cards, which are located on the left panel of the router. The router can be equipped with a WiFi module, but this must be part of the initial configuration – it cannot be added to the router at some point in the future. The router can be provided only in a metal casing.

Configuration of the router may be done via a password-protected Web interface. Web interface provides detailed statistics about the router's activities, signal strength, detailed system log etc. The router supports the creation of VPN tunnels using IPSec, OpenVPN and L2TP to ensure safe communication. DHCP, NAT, NAT-T, DynDNS, NTP, VRRP, control by SMS, backup primary connection and many other functions are supported.

The router provides diagnostic functions which include automatically monitoring the PPP connection, automatic restart in case of connection losses, and a hardware watchdog that monitors the router status. The user may insert Linux scripts which are started on various actions. It is possible to create up to four different configurations for the same router. These configurations can be switched whenever necessary via Web interface, SMS or binary input status. The router can automatically upgrade its configuration and firmware from your central server. This allows for mass reconfiguration of numerous routers at the same time.

Examples of possible applications

- mobile office
- fleet management
- security system
- telematic
- telemetric
- remote monitoring
- vending and dispatcher machines

4.1 Usage of the Router

The router is primarily intended for these four basic situations:

I. Access to the Internet from LAN

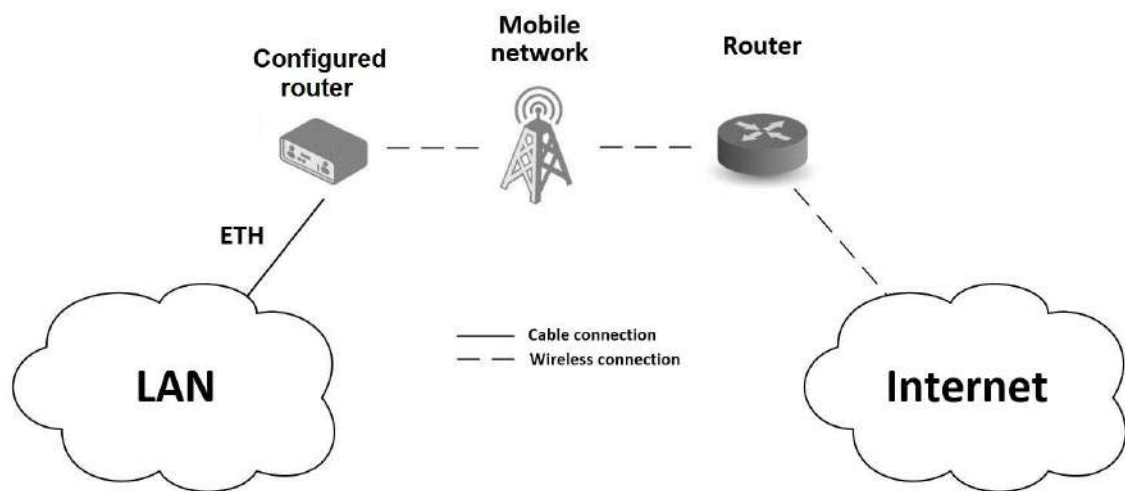

Figure 1: Access to the Internet from LAN

II. Backed up access to the Internet (from LAN)

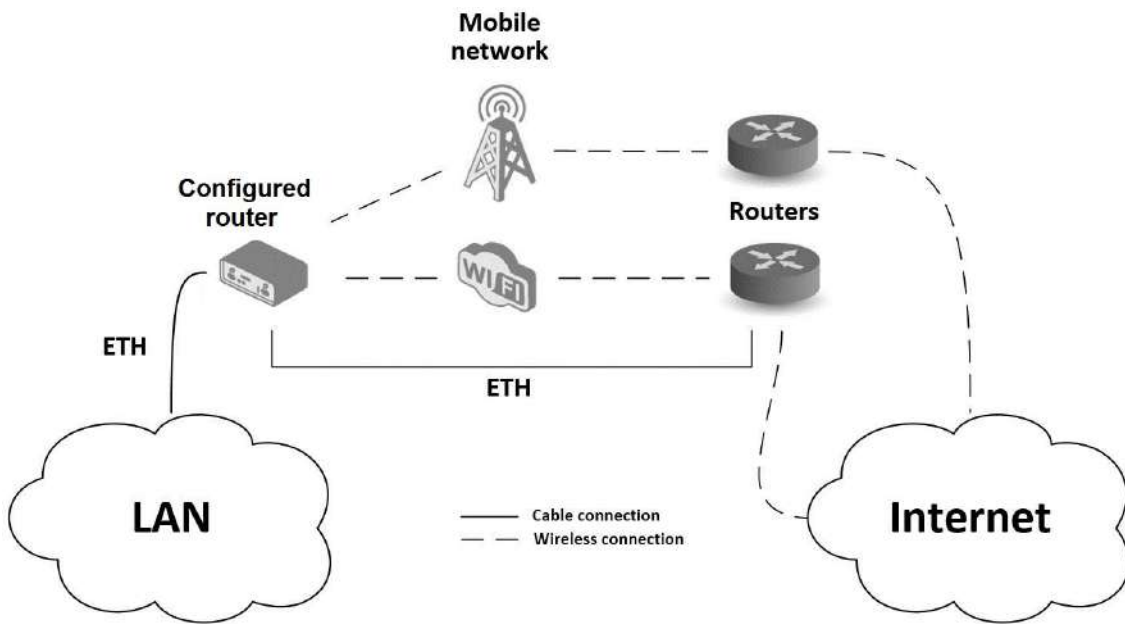

Figure 2: Backed up access to the Internet

III. Secure networks interconnection or using VPN

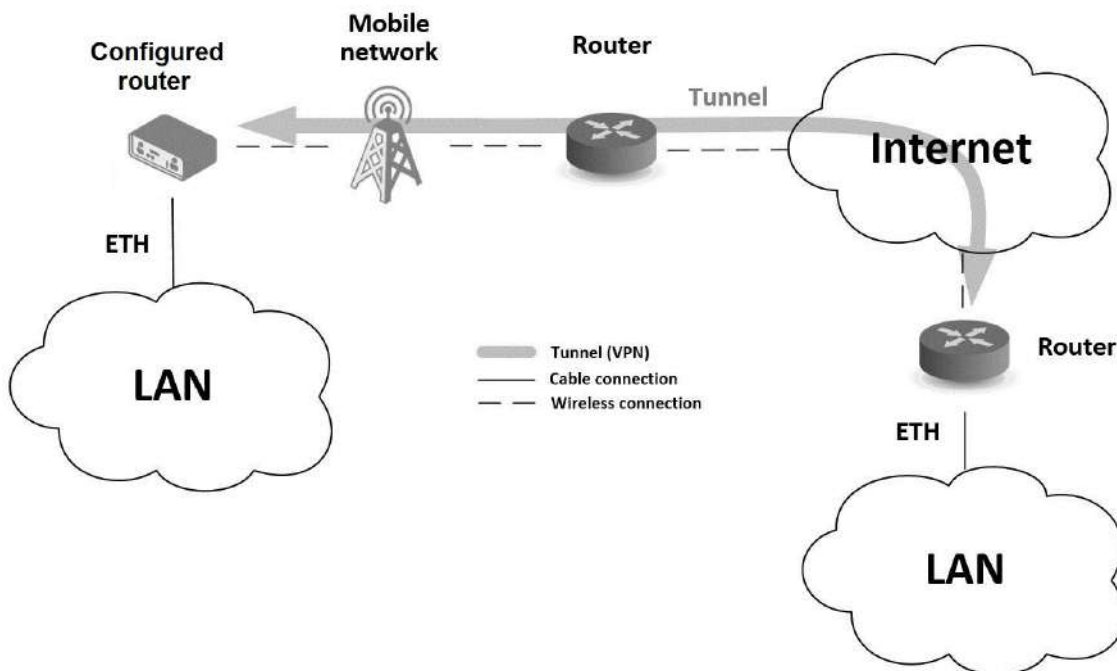

Figure 3: Using VPN tunnel

IV. Serial Gateway

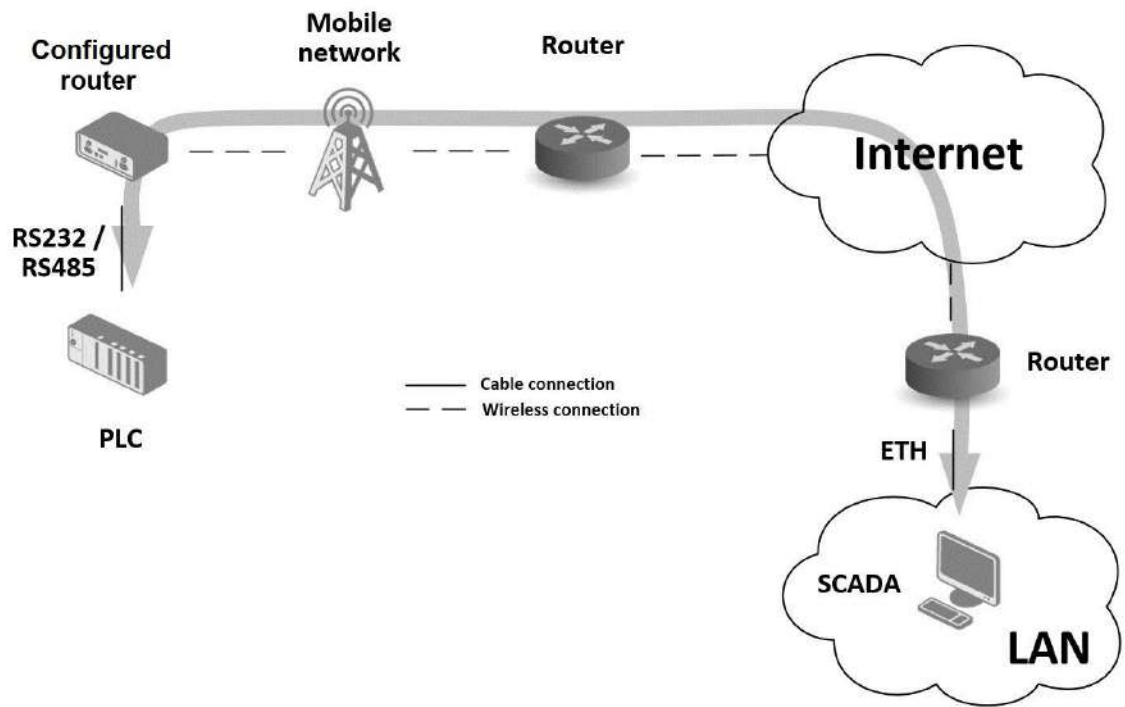

Figure 4: Serial Gateway

5 Contents of Package

The standard set of router includes items listed in following table:









Item#	Description	Figure	Q'ty
1	Router		1 pcs
2	DIN holder (screwed on the router)		1 pcs
3	Wing on wall mounting (screwed on the router)		2 pcs
4	2-pin terminal block for power supply (deployed on the router)		1 pcs
5	10-pin terminal block for RS232, RS485 and I/O (deployed on the router)		1 pcs
6	Printed "General Safety Instructions"		1 pcs
7	Printed "Open Source Information OWL Family"		1 pcs
8	Printed "EU Declaration of Conformity"		1 pcs

Table 1: Contents of package

6 Router Design

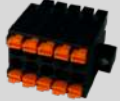
6.1 Router Versions

OWL 4G Europe router is supplied in the following versions (see table below). All versions are available in metal box.

Router versions	SIM	BIN	BOUT	ETH	WiFi	GNSS	RS232	RS485
Version without WiFi and GNSS	2 x	1 x	1 x	2 x			1 x	1 x
Version with WiFi and GNSS	2 x	1 x	1 x	2 x	1 x	1 x	1 x	1 x

Table 2: Router versions



Figure 5: Version without WiFi and GNSS



Figure 6: Version with WiFi and GNSS

6.2 Order codes

Order codes overview is shown in the table below.

Product type	Product name	Order code	Features – interfaces
OWL 4G	OWL 4G Europe	942 283-001	LTE module for EMEA, 2x ETH, 1x BI, 1x BO, 1x RS232, 1x RS485, 2x SIM reader
OWL 4G	OWL 4G Europe + WLAN	942 283-101	LTE module for EMEA, 2x ETH, 1x BI, 1x BO, 1x RS232, 1x RS485, 2x SIM reader, WiFi, GNSS

Table 3: Order Codes Overview

6.3 Basic Dimensions of the Router Box (specified in mm)

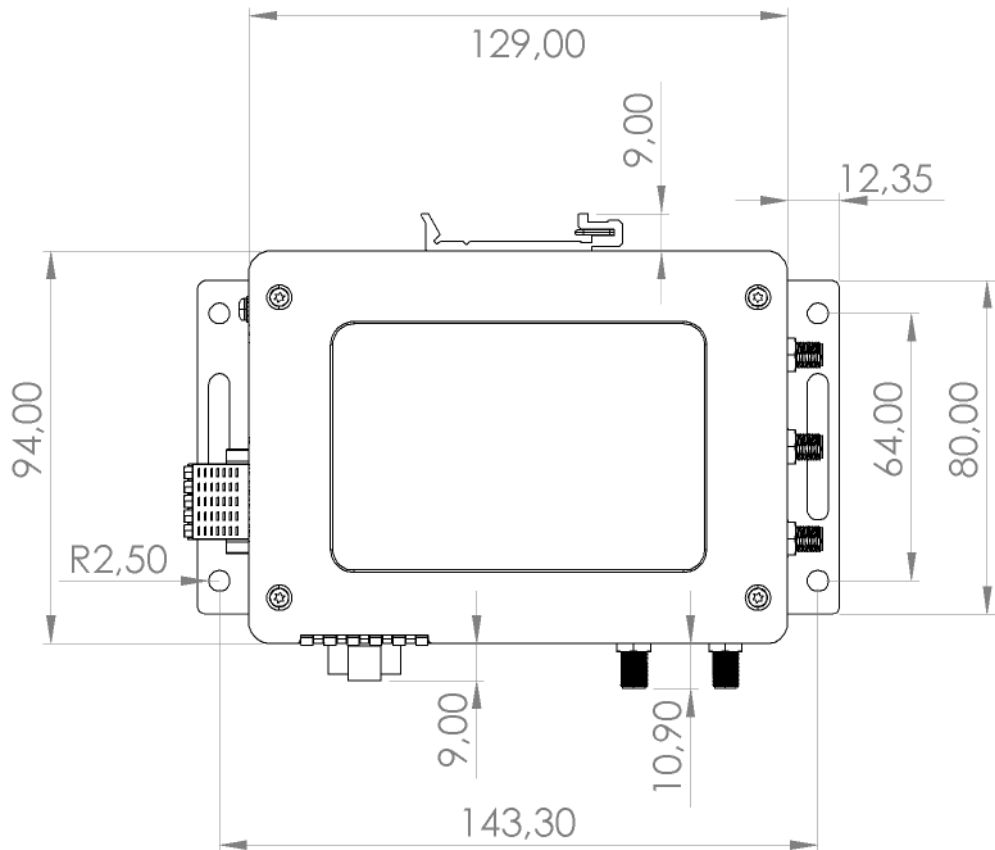

Figure 7: Basic dimensions of the router box

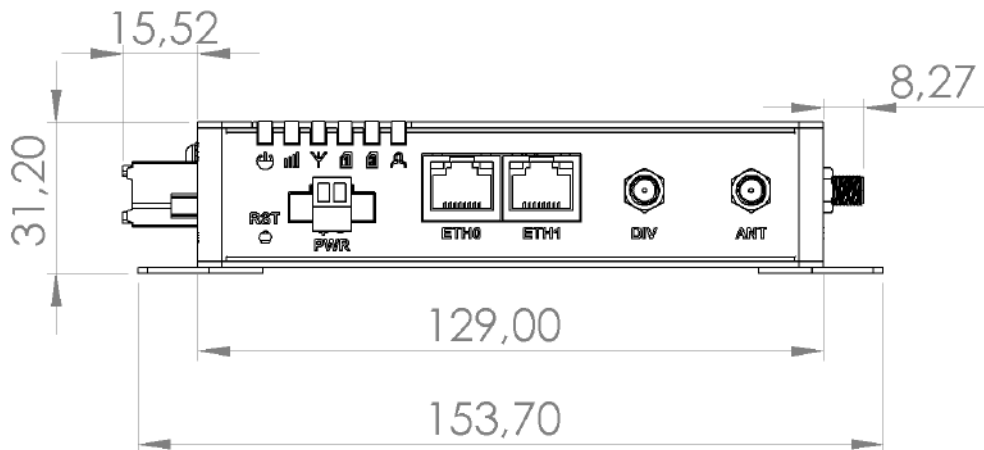

Figure 8: Basic dimensions of the router box

6.4 Mounting Recommendations

Router can be placed:

- on a flat surface,
- on a wall (or other surface) using the side wings,
- on a DIN rail EN 60715 with the included metal DIN rail clip.

If the negative pole of the router is grounded, there is no protection against reversed polarity! The only protection left is the fuse inside the device. Only the service center can restore the router's functionality.



6.5 Removing from the DIN Rail



The DIN rail clip is suitable for a DIN rail according to EN 60715 standard only. The default position of metal rail clip, which is used for mounting the router on a DIN rail, is shown in the following figure. Its position can be changed on some models (back or bottom). When changing the position of the DIN rail clip, tighten the screws with max. 0.4 Nm torque.



Figure 9: Default position of DIN rail clip

To remove the router from the DIN rail it is necessary to lightly push down the router so that the bottom part of the DIN rail clip hitched to the DIN rail get out of this rail and then fold out the bottom part of the router away from the DIN rail.

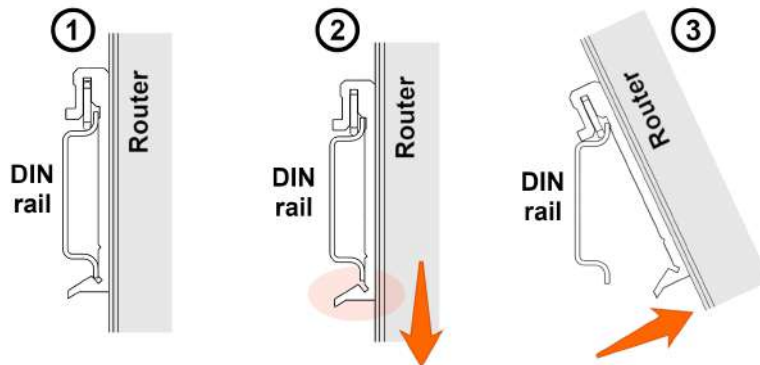

Figure 10: Removing from the DIN rail

6.6 Description of the Front Panel

On the front panel of the router, there are located:

Caption	Connector	Description
RST	—	<i>RST</i> button used to restore the default configuration and re-boot the router
PWR	2-pin	Terminal block for the power supply
ETH0	RJ45	Ethernet connection to the computer network
ETH1	RJ45	Ethernet connection to the computer network
DIV	SMA	Connector for diversity antenna
ANT	SMA	Connector for main antenna

Table 4: Description of the front panel



Figure 11: The front panel of the router

6.6.1 Status Indication

There are six LED indicators on the front panel to provide router status information. Each ETH port has two additional LEDs that provide information about the port status.







	Caption	Color	State	Description
	PWR	Green Green Green	On Blinking Fast blinking	Starting of the router Router is ready Updating firmware
	SIG	Green Orange Red	On On On	Good signal Fair signal Poor signal
	DAT	Green	Blinking	Communication in progress on radio channel
	SIM1	Green Green Orange Red Red	Blinking On On On Fast blinking	SIM is selected, router waits for data connection 4G technology 3G technology 2G technology SIM card problem (missing SIM card or PIN code not entered)
	SIM2	Green Green Orange Red Red	Blinking On On On Fast blinking	SIM is selected, router waits for data connection 4G technology 3G technology 2G technology SIM card problem (missing SIM card or PIN code not entered)
	USR	Green	On / Blinking / Fast blinking	Function of this LED diode can be selected by user
	ETH0 ETH1	Green Green	On Off	Selected 100 Mbps Selected 10 Mbps
	ETH0 ETH1	Yellow Yellow Yellow	On Blinking Off	The network cable is connected Data transmission The network cable is not connected

Table 5: Status indication

6.6.2 Power Connector PWR

Terminal block 3.5 mm.

Pin number	Signal mark	Description
1	VCC(+)	Positive pole of DC supply voltage (+9 to +36 V DC)
2	GND(-)	Negative pole of DC supply voltage

Table 6: Connection of power connector

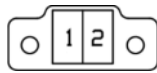

Figure 12: Power connector

Power supply for router is required between +9 V to +36 V DC supply. Protection against reversed polarity without signaling is built into the router.

If the negative pole of the router is grounded, there is no protection against reversed polarity! The only protection left is the fuse inside the device. Only the service center can restore the router's functionality.



For correct operation it is necessary that the power source is able to supply a peak current of 1.2 A.

Unit has to be supplied by a power supply specified as a Limited Power Source (LPS) or CEC/NEC Class 2 source of supply.



In applications requiring low power consumption (such as solar power - not 7/24 mode) is strictly recommended to use "LPM" mode prior to powering down the entire router.



Circuit example:



Figure 13: Connection of power supply

All metal parts, including the box, are connected together with the negative pole of power supply (common pole). To ground the router can be used the grounding screw located on the left panel.



6.6.3 Ethernet Port ETH0 and ETH1

The panel socket of RJ45 is used for this interface. The insulation strength of Ethernet ports from each other and from the rest of the router (grounding) is 1500 V.

Pin	Signal mark	Description	Data flow direction
1	TXD+	Transmit Data – positive pole	Input/Output
2	TXD-	Transmit Data – negative pole	Input/Output
3	RXD+	Receive Data – positive pole	Input/Output
4	—	—	
5	—	—	
6	RXD-	Receive Data – negative pole	Input/Output
7	—	—	
8	—	—	

Table 7: Connection of Ethernet connector

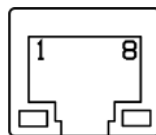

Figure 14: Ethernet connector

The Ethernet cable plugs into the RJ45 connectors labeled as ETH0 and ETH1 (see the figure below).

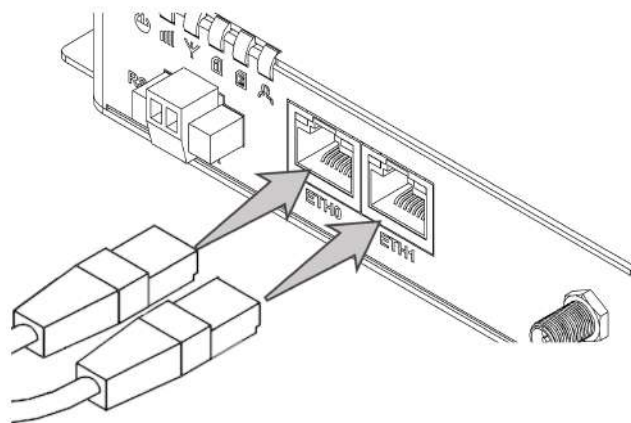

Figure 15: Connection of Ethernet cables

6.6.4 ANT, DIV, GNSS and WiFi Antenna Connectors

The main and diversity antennas are connected to the router using the SMA connectors on the front panel. For the WiFi version, there are also two R-SMA connectors for connection of the WiFi antennas and one SMA connector for connection of the GNSS antenna on the right panel of the router.

The *ANT* connector is used to connect the main antenna to the router. To connect the diversity antenna, the second antenna connector *DIV* is used. The R-SMA connectors named *WiFi1* and *WiFi2* are designed for the connection of WiFi antennas. The *GNSS* connector is used to connect the GNSS antenna.

The router can not operate without a main antenna connected through the port marked as *ANT*.



The SMA connector is used for the connection of the antenna. Recommended tightening moment for screwing the antenna to the SMA connector is 0.9 Nm.

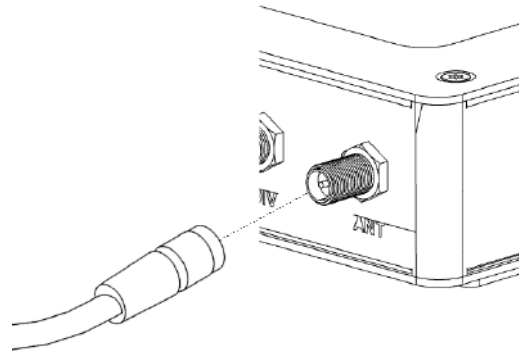

Figure 16: Connecting the antenna

The diversity antenna improves the radio capability of the router at low signal strength.



6.6.5 Reset Button

The *RST* button on the front panel has three functions on OWL 4G routers:

- Reboot the router:

Hold the *RST* button for less than 4 seconds, the router will be restarted.

- Factory reset – restore the default configuration:

Hold the *RST* button for more than 4 seconds. The *PWR* LED turns off and on again. We recommend holding down the *RST* button for 1 second after turning on the *PWR* LED on the front panel.

- Factory reset – restore the default configuration when unable to boot:

If the router is unable to boot due to a bad configuration, turn off the router (power supply). Push and hold the *RST* button, turn on the router and hold the *RST* button for at least 10 seconds. This will return the router to default configuration.



Before performing the factory reset of the router, it is recommended to back up the router configuration settings (see "Configuration OWL 4G Family" user manual) because reset of the router will return all configuration settings to their default states.

You can download the "Configuration OWL 4G Family" user manual on the Internet at: <https://www.doc.hirschmann.com/>.



In order to press the *RST* button it is necessary to use a narrow screwdriver or any other small tool.



Figure 17: Router reset

Action	Router behavior	Trigger events – options
Reboot	Turns off and then turns on the router	<ul style="list-style-type: none"> • Disconnect and reconnect the power • Send text <i>reboot</i> via SMS to SIM card number put in your router (your phone number has to be authorized – see the Configuration Manual for OWL 4G routers) • Press the <i>Reboot</i> menu item in the Web interface • Press the <i>RST</i> button, hold less than 4 seconds
Reset (factory)	Restores the default configuration and reboots the router	<ul style="list-style-type: none"> • Hold the <i>RST</i> button for more than 4 seconds • If it does not help (router does not start at all), turn off the router (power supply). Push and hold the <i>RST</i> button, then turn on the router and hold the <i>RST</i> button for more than 10 seconds.

Table 8: Overview of router reboot and reset

6.7 Description of the Left Panel

Interfaces located on the left panel are described in the table below.

Caption	Connector	Description
Grounding screw	M3 screw	Grounding screw (M3x6L) is connected to the ground of the board and to the negative pole of the power source.
SIM cards	2FF size	Unscrew the SIM cards cover to access the SIM1 and SIM2 slots.
SERIAL I/O	10-pin	This connector has the RS232 and RS485 serial interfaces, one binary input and one binary output. The connector pinout is printed on the top label.

Table 9: Description of the left panel



Figure 18: The left panel of the router

6.7.1 SIM Card Reader

Two SIM card readers for 3 V and 1.8 V SIM cards are located on the left panel of the router. In order for the router to function, it is necessary to insert an activated SIM card with an unblocked PIN code, or you can enter the PIN code in the router web interface. The SIM cards may have different adjusted APNs (Access Point Names).

Type of SIM cards: Mini SIM (2FF) 25.0 x 15.0 x 0.76 mm.



Changing the SIM card:

- Always disconnect the router from power supply before handling the SIM card!
- Unscrew the SIM card cover.
- Using a plastic opening tool, or your fingernail, press the SIM card slightly into its slot until you hear a click.
- After hearing this click, release the card and it will pop out of its slot.
- Remove the SIM card and push any other SIM card into the slot until it clicks into place.



Figure 19: SIM card reader

6.7.2 Serial Interfaces and I/O Port

The RS232 and RS485 serial interfaces together with the I/O interface are physically connected to the 10-pin panel socket. All three interfaces are not isolated from the router. The pinout of this connector is described in the tables below.

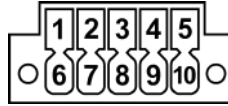

Figure 20: Serial + I/O connector

Pin	Signal mark	Description
1	B (+)	IN/OUT
2	A (-)	IN/OUT
3	GND	GROUND

Table 10: Connection of RS485

Pin	Signal mark	Description
4	BIN	BINARY IN
5	BOUT	BINARY OUT

Table 11: Connection of I/O

Pin	Signal mark	Description
6	RXD	IN
7	CTS	IN
8	GND	GROUND
9	RTS	OUT
10	TXD	OUT

Table 12: Connection of RS232

The I/O user interface is designed for binary input processing and binary output control. By default, the binary output is open, so it is not grounded. The maximum binary output load is 36 V at 500 mA. The constant current supplied by the binary input is 3 mA.

The functional scheme of connection for the binary input and binary output is drawn on the picture below.

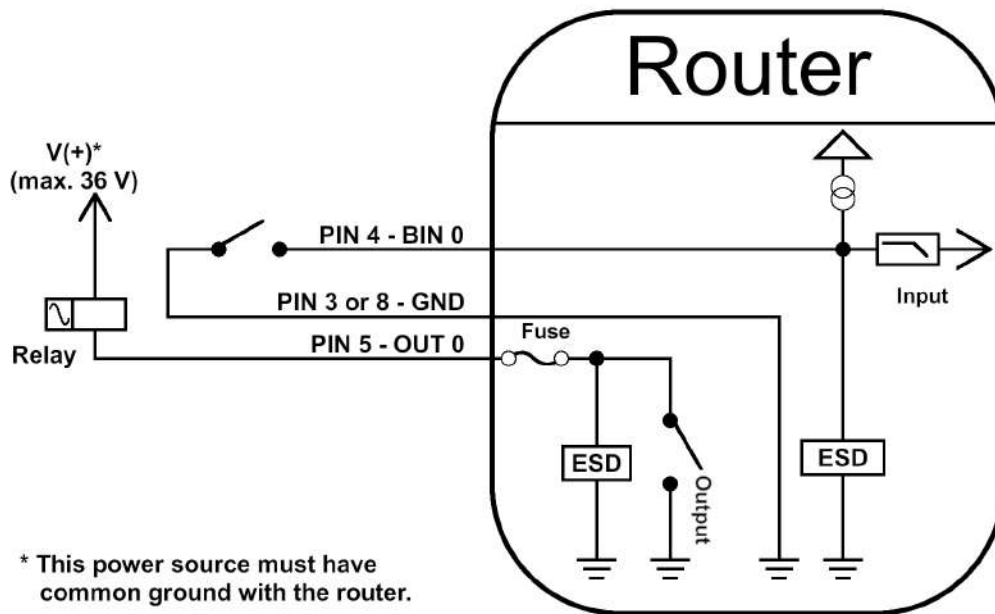

Figure 21: Functional scheme of the binary interface

6.8 Description of the Right Panel

Connectors located on the right panel are described in the table below. This panel has no connectors on it for the non-WiFi version of the router.

Caption	Connector	Description
WiFi2	R-SMA	Connector for the second WiFi antenna.
GNSS	SMA	Connector for the GNSS receiver antenna.
WiFi1	R-SMA	Connector for the first WiFi antenna.

Table 13: Description of the right panel



Figure 22: The right panel of the router

7 First Use

7.1 Connecting the Router Before First Use

Before putting the router into operation it is necessary to connect all of the components that are required to run your applications. Don't forget to insert a SIM card.

The router can not operate without a connected antenna, SIM card and power supply. If the antenna is not connected, the router may be damaged.



Be very careful when tightening the antenna. If you over tighten the antenna, then you can twist the antenna connector off of the circuit board.



7.2 Start

The router will start when a power supply is connected to the router. By default, the router will automatically start to log on to the default APN. The DHCP server will start to assign addresses for devices connected through the Ethernet port ETH0. Router's behavior can be changed via the web interface. This is described in detail in the "*Configuration OWL 4G Family*" user manual that you can download at: <https://www.doc.hirschmann.com/>.

7.3 Configuration

If no SIM card is inserted in the router, it is not possible for the router to operate. Any inserted SIM card must have active data transmission.



7.3.1 Configuration using a Web Browser

For status monitoring, configuration and administration of the router a web interface is available which can be accessed by entering the IP address of the router into the web browser. The default IP address of the router is 192.168.1.1 netmask 255.255.255.0.

Use the HTTPS protocol to help maintain secure communication.



Applies to devices that are delivered without unique default password

- The default settings allow only the user "admin" with the default password "private" to configure the router.
- After successfully entering the login information a user has access to the router using the Internet browser.

Applies to devices that are delivered with a unique default password that is located on a label on the device

Perform the following steps:

1. Open the web interface the first time you log on to the device.
2. Type in the user name "admin".
3. Type in the unique default password that is located on a label ("Def. password") on the device.
4. Click the "Login" button. After successfully entering the login information you have access to the router using the Internet browser.
5. **To help maintain the security of your network, change the unique default password of the router.**



Some features may be disabled until you change the unique default password.



The unique default password will be applied again if you reset the router by the "Reset" button.



You find a detailed description of the router settings in the Web interface in the "User Manual Configuration OWL 4G Family". You can download the PDF on the Internet at: <https://www.doc.hirschmann.com/>.

8 Maintenance and Service

- When designing this device, Hirschmann largely avoided using high-wear parts. The parts subject to wear and tear are dimensioned to last longer than the lifetime of the product when it is operated normally. Operate this device according to the specifications.
- Relays are subject to natural wear. This wear depends on the frequency of the switching operations. Check the resistance of the closed relay contacts and the switching function depending on the frequency of the switching operations.
- Hirschmann is continually working on improving and developing their software. Check regularly whether there is an updated version of the software that provides you with additional benefits. You find information and software downloads on the Hirschmann product pages on the Internet (<https://hirschmann.com>).

Note: You find information on settling complaints on the Internet at <http://www.beldensolutions.com/en/Service/Repairs/index.phtml>.

9 Technical Parameters

9.1 Basic Parameters

Router parameters		
Temperature range	Operating Storage	-40 °C to +65 °C -40 °C to +85 °C
Humidity	Operating Storage	0 to 95 % relative humidity non condensing 0 to 95 % relative humidity non condensing
Altitude	Operating	2000 m / 70 kPa
Degree of protection		IP30
Supply voltage		9 to 36 V DC
Battery for RTC		CR1225
Consumption	Idle Average Peak Sleep mode	2.5 W 4 W 11 W 10 mW
Dimensions of device		31.2 x 94 x 129 mm
DIN rail clip dimensions		DIN 35 mm, EN 60715
Weight	Metal box	477 g for version without WiFi and GNSS 497 g for version with WiFi and GNSS
Antenna connectors		2x SMA for LTE – 50 Ω 1x SMA for GNSS – 50 Ω (with WiFi and GNSS) 2x R-SMA – 50 Ω (versions with WiFi, GNSS)
User interface	2x ETH SERIAL I/O	Ethernet RJ-45 (10/100 Mbit/s) 10-pin panel socket Terminal Block (for RS232, RS485 and I/O)

Table 14: Basic parameters

9.2 Standards and Regulations

The router complies with the following standards and regulations:

Standards and regulations	
Radio	EN 301 511, EN 301 908-1, EN 301 908-2, EN 301 908-13, EN 303 413, EN 301 893, EN 300 328
EMC	EN 301 489-1, EN 301 489-19, EN 301 489-52, EN 301 489-17, EN 61000-6-2, EN 61000-6-4
Safety	UL/EN/AS/NZS 62368-1
Transportation	E-Mark E8 homologation number: 10R – 05 10350, EN 45545-2
National	CE compliant
Environmental	REACH, RoHS3 and WEEE compliant

Table 15: Standards and regulations

9.3 Type Tests and Environmental Conditions

Phenomena	Test	Description	Test levels
ESD	EN 61000-4-2	Enclosure contact Enclosure air	± 6 kV (crit. A) ± 8 kV (crit. A)
RF field AM modulated	EN 61000-4-3	Enclosure	10 V/m (crit. A) (80 – 2700 MHz) 3 V/m (crit. A) (2700 – 6000 MHz)
Fast transient	EN 61000-4-4	Signal ports Power ports Ethernet ports	± 1 kV (crit. A) ± 2 kV (crit. A) ± 1 kV (crit. A)
Surge	EN 61000-4-5	Ethernet ports Power ports	± 1 kV (crit. A), shielded cab. ± 0.5 kV (crit. A)
RF conducted	EN 61000-4-6	All ports	10 V/m (crit. A) (0.15 – 80 MHz)
Radiated emission	EN 55032	Enclosure	Class B
Conducted emission	EN 55032	DC power ports Ethernet ports	Class B Class B
Dry heat	EN 60068-2-2	+65 °C *, 40 % rel. humidity	
Cold	EN 60068-2-1	-40 °C *	
Dump heat	EN 60068-2-78	95 % rel. humidity (+40 °C)	
Vibration	EN 60068-2-64 ed. 2	Vibration spectrum A.3 (rolling stock)	Category 1 (3 axis, 8 hours per axis)
Shock	EN 60068-2-27 ed. 2	half-sine, 50 g peak, 11 ms	

Table 16: Type tests and environmental conditions

9.4 Technical Parameters of Cellular Module

Technical parameters of cellular module	
LTE parameters	LTE: Cat.4, 3GPP E-UTRA Release 11 FDD frequencies: B28A (700 MHz), B20 (800 MHz), B8 (900 MHz), B3 (1800 MHz), B1 (2100 MHz), B7 (2600 MHz) TDD frequencies: B40 (2300 MHz), B41 (2500 MHz), B38 (2600 MHz) LTE FDD bit rates: 150 Mbps (DL) / 50 Mbps (UL) LTE TDD bit rates: 130 Mbps (DL) / 35 Mbps (UL) Supported bandwidths: 1.4 MHz, 3 MHz, 5 MHz, 10 MHz, 15 MHz, 20 MHz
HSPA+ parameters	HSPA: 3GPP R8 DC-HSPA+ Supported frequencies: B8 (900 MHz), B1 (2100 MHz) Bit rates: 42 Mbps (DL) / 5.76 Mbps (UL)
UMTS parameters	Supported frequencies: B8 (900 MHz), B1 (2100 MHz) Bit rates: 384 kbps (DL) / 384 kbps (UL)
EDGE parameters	Supported frequencies: 900 MHz, 1800 MHz Data throughput: max. 236.8 kbps
GPRS parameters	Supported frequencies: 900 MHz, 1800 MHz Data throughput: max. 85.6 kbps

Table 17: Technical parameters of cellular module

Antenna Requirements

- VSWR: <2:1 (Antenna input impedance response as function of frequency. This shows the antenna resonances and its bandwidth).
- SMA: 50 Ω
- For good diversity performance, the primary and secondary antennas should have different polarizations.

9.5 Technical Parameters of WiFi

WiFi	
Antenna connector	2x R-SMA – 50 Ω (MU-MIMO)
Supported WiFi bands	2.412 to 2.472 GHz, 5.180 to 5.825 GHz
Standards	IEEE: 802.11b, 802.11b+g, 802.11b+g+n, 802.11a, 802.11a+n, 802.11ac
2.4 GHz supported channels	1, 2, 3, 4, 5, 6, 7, 8, 9, 10, 11, 12, 13
5 GHz supported channels	36, 40, 44, 48, 149, 153, 157, 161, 165
Type of device	Access point, Station
Security – Standards	WEP, WPA, WPA2, 802.1X
Security – Encryption	WEP, TKIP, AES
Security – EAP Types	EAP-FAST, EAP-TLS, EAP-TTLS, PEAP-GTC, PEAP-MSCHAPv2, PEAP-TLS, LEAP

Table 18: Technical parameters of WiFi

9.6 Technical Parameters of GNSS

GNSS specifications	
Antenna	50 Ω – active
Protocols	NMEA 0183
GNSS Systems	GPS, GLONASS, BeiDou, Galileo, QZSS
Frequency	GPS/Galileo/QZSS: 1575.42 ± 1.023 MHz GLONASS: 1597.5 – 1605.8 MHz BeiDou: 1561.1 ± 2.046 MHz
Sensitivity (autonomous)	Tracking: -157 dBm Reacquisition: -157 dBm Cold start: -146 dBm
Acquisition time (autonomous)	Hot start: 2.5 s Warm start: 26 s Cold start: 35 s
Accuracy	< 1.5 m

Table 19: Technical parameters of GNSS

9.7 Other Technical Parameters

Other technical parameters	
CPU power	2 DMIPS per MHz
Flash memory	Available memory space 1862 MB <ul style="list-style-type: none">• 2x 256 MB – FW• 512 MB – User data storage• 838 MB – Space for User Modules
RAM	512 MB

Table 20: Other technical parameters

10 Related Documents

The “Configuration” user manual, Application Notes, and documentation of several OWL user modules can be found as PDF files for downloading on the Internet at:

<https://www.doc.hirschmann.com/>.

11 Further Support

Technical questions

For technical questions, please contact any Hirschmann dealer in your area or Hirschmann directly.

You find the addresses of our partners on the Internet at <http://www.hirschmann.com>.

A list of local telephone numbers and email addresses for technical support directly from Hirschmann is available at <https://hirschmann-support.belden.com>.

This site also includes a free of charge knowledge base and a software download section.

Hirschmann Competence Center

The Hirschmann Competence Center is ahead of its competitors on three counts with its complete range of innovative services:

- Consulting incorporates comprehensive technical advice, from system evaluation through network planning to project planning.
- Training offers you an introduction to the basics, product briefing and user training with certification. You find the training courses on technology and products currently available at <http://www.hicomcenter.com>.
- Support ranges from the first installation through the standby service to maintenance concepts.

With the Hirschmann Competence Center, you decided against making any compromises. Our client-customized package leaves you free to choose the service components you want to use.

Internet:

<http://www.hicomcenter.com>



HIRSCHMANN

A **BELDEN** BRAND